

 **KINETIC  
BALANCE  
POSITIONING  
PRODUCTS**

---

**PRODUCT  
RANGE**

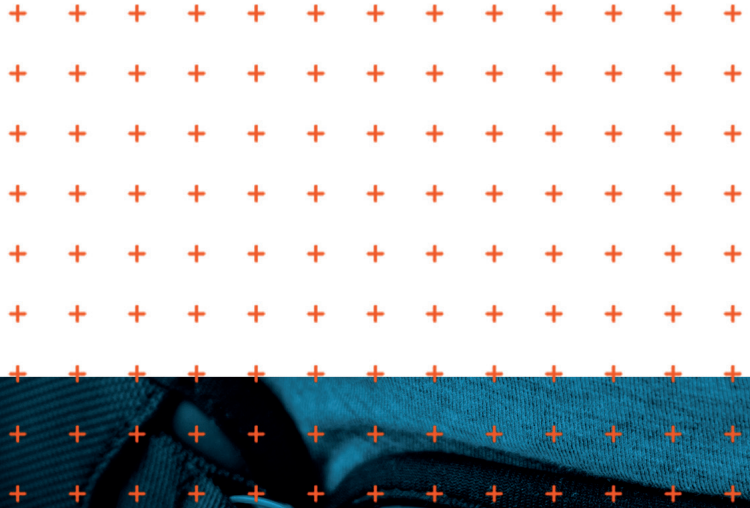

**MORE INFO:  
[POSITIONINGPRODUCTS.NL](http://POSITIONINGPRODUCTS.NL)**

---



# POSITIONING MATTERS



■ HIP BELTS	4/8
2-POINT HIP BELTS	6
4-POINT HIP BELTS	8
■ CHEST POSITIONING STRETCH	10/11
■ CHEST POSITIONING NON-STRETCH	12/13
■ PELVIC POSITIONING	16
■ ANKLE POSITIONING	17
■ ABDUCTION POSITIONING	18
■ ASSORTED PRODUCTS	20/23
NEOPRENE CHEST BELT X	20
CHEST BELT V1	21
SHOWER BELT	22
NEOPRENE MULTI-PURPOSE BAND	23
■ PRODUCT CHARACTERISTICS	24/25
■ PRODUCT OVERVIEW	26/27

At Positioning Products, we believe that everyone deserves to feel good in their body, live a healthy life, and enjoy comfort. Therefore, by paying attention to the details and listening to our clients and users, we design durable, high-quality, good-looking belts and harnesses that improve the health of wheelchair users.





# HIP BELTS: BUCKLES AND ADJUSTMENTS

Incorrect seating posture can negatively affect a person's body, and could lead to pain and poor circulation, digestion, and breathing.

Having a good seating posture starts with positioning the pelvis, which is the basis of seating.

The initial step to good posture is to properly fit the wheelchair to the user's needs, which requires providing support under the seating surface, good sizing of the seat (not too long, not too short, not too narrow and not too wide), finding the correct height and width of the backrest, leg- and arm support.

However, sometimes, the wheelchair alone cannot solve users' postural deviation. Therefore, we have designed a wide range belts and harnesses, which can further assist in positioning the user.

Our Hip Belts come with various buckles and are either single or double-adjustable. The Hip Belts tackle problems like:

- + Posterior Pelvic Tilt
- + Anterior Pelvic Tilt
- + Pelvic Rotation
- + Pelvic Obliquity

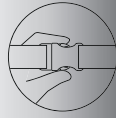

**SIDE RELEASE**  
**SINGLE ADJUSTABLE**

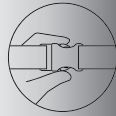

**SIDE RELEASE**  
**DOUBLE ADJUSTABLE**

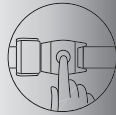

**CENTER RELEASE**  
**SINGLE ADJUSTABLE**

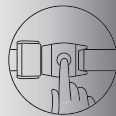

**CENTER RELEASE**  
**DOUBLE ADJUSTABLE**

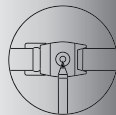

**PIN RELEASE**  
**DOUBLE ADJUSTABLE**

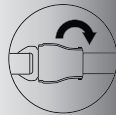

**AVIATION RELEASE**  
**SINGLE ADJUSTABLE**





# 2-POINT HIP BELTS



- + + +
- + + +
- + + +
- + + +
- + + +

The 2 - point Hip Belts Single Adjustable are designed to resolve posterior pelvic tilt. The 2 - point Hip Belts Double Adjustable are made to solve pelvic obliquity and posterior pelvic tilt. They all come with various release types (buckles), which can be chosen based on the abilities and needs of the user.

## 2-POINT ESSENTIAL HIP BELT SINGLE ADJUSTABLE

Article number: 6.70000.2  
Size: M

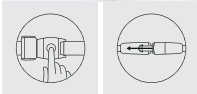

## 2-POINT HIP BELT SIDE RELEASE DOUBLE ADJUSTABLE

Article number: 6.70001.x  
Size: XS ro XL

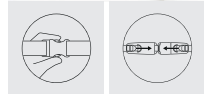

## 2-POINT HIP BELT SIDE RELEASE SINGLE ADJUSTABLE

Article number: 6.70002.x  
Size: XS to XL

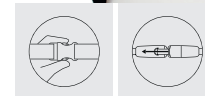

## 2-POINT HIP BELT CENTRE RELEASE SINGLE ADJUSTABLE

Article number: 6.70003.x  
Size: XS to XL

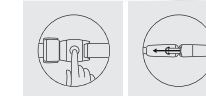

## 2-POINT HIP BELT CENTRE RELEASE DOUBLE ADJUSTABLE

Article number: 6.70004.x  
Size: XS to XL



## 2-POINT HIP BELT PIN RELEASE DOUBLE ADJUSTABLE

Article number: 6.70005.x  
Size: XS to XL

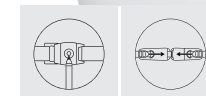

## 2-POINT HIP BELT AVIATION RELEASE SINGLE ADJUSTABLE

Article number: 6.70006.x  
Size: S to XL

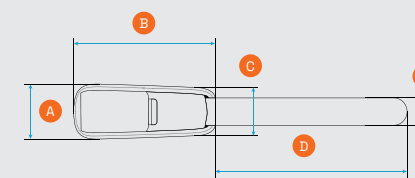
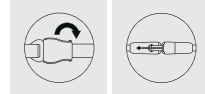

	A	B	C	D	E
XS	60	180	45	580	25
S	70	180	55	650	38
M	80	225	60	750	38
L	85	285	60	800	38
XL	100	335	70	800	38

All measurements in mm



# 4-POINT HIP BELTS

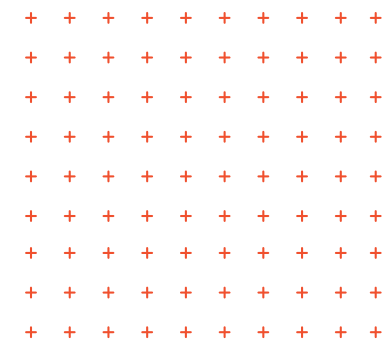

## 4-POINT HIP BELT SIDE RELEASE DOUBLE ADJUSTABLE

Article number: 6.70044.x  
Size: XS to XL



## 4-POINT HIP BELT PIN RELEASE DOUBLE ADJUSTABLE

Article number: 6.70045.x  
Size: XS to XL



## 4-POINT HIP BELT CENTRE RELEASE SINGLE ADJUSTABLE

Article number: 6.70047.x  
Size: XS to XL

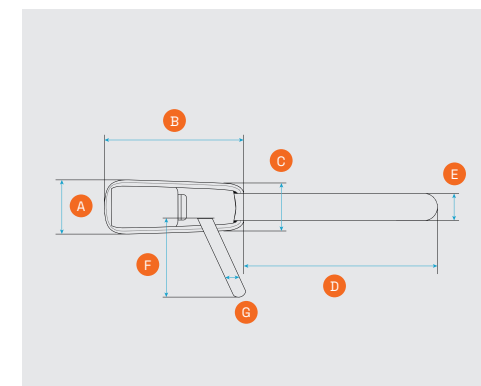

	A	B	C	D	E	F	G
XS	60	180	45	580	25	500	20
S	70	180	55	650	38	500	25
M	80	225	60	750	38	600	25
L	85	285	60	800	38	700	25
XL	100	335	70	800	38	700	25

All measurements in mm



The 4 - point Hip Belts Single Adjustable are design to resolve anterior pelvic tilt. The 4 - point Hip Belts Double Adjustable are made to solve pelvic rotation and anterior pelvic tilt. They are all made for people, who need 3 - dimensions support, and come with various release types (buckles), which can be chosen based on the abilities and needs of the user.

## 4-POINT HIP BELT SIDE RELEASE SINGLE ADJUSTABLE

Article number: 6.70042.x  
Size: XS to XL



## 4-POINT HIP BELT CENTRE RELEASE DOUBLE ADJUSTABLE

Article number: 6.70043.x  
Size: XS to XL





# CHEST POSITIONING STRETCH

## CHEST POSITIONING STRETCH

Article number: 5.71012.x

Size: XS to L



## X-CHEST POSITIONING STRETCH

Article number: 5.71014.x

Size: S to L



## CHEST POSITIONING ZIPPER STRETCH

Article number: 5.71022.x

Size: S to M



ALWAYS MUST BE USED IN COMBINATION WITH A HIP BELT



The Chest Positioning Stretch harnesses give trunk support and come in three different designs to meet the needs of every user.

While the Chest Positioning Stretch has a wide contact area to distribute the support, X-Chest Positioning Stretch has a more local contact area and, therefore, gives central support. The Chest Positioning Zipper Stretch comes with a zipper that allows easy removal for users who frequently transfer from and to their wheelchairs.

Their products' stretchiness, which improves respiration, is achieved by carefully selecting the perfect material.

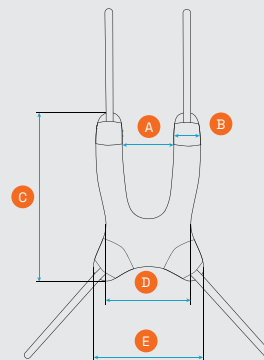

	A	B	C	D	E
XS	55	50	235	100	190
S	70	55	315	160	220
Junior	65	55	275	150	200
M	100	60	360	180	240
L	130	60	400	200	250
XL	180	60	470	245	300

All measurements in mm

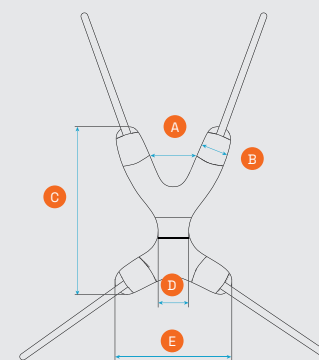

	A	B	C	D	E
S	70	60	320	70	230
M	100	60	375	70	265
L	120	65	425	70	300

All measurements in mm

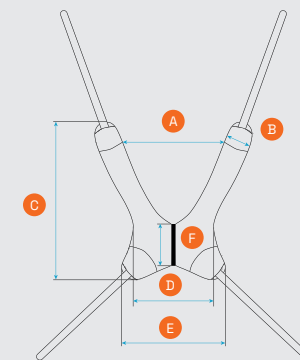

	A	B	C	D	E	F
S	130	55	310	85	140	200
M	200	60	350	85	170	250

All measurements in mm



# CHEST POSITIONING NON-STRETCH



ALWAYS MUST BE USED IN COMBINATION WITH A HIP BELT

## CHEST POSITIONING FLEX-CONTROL / NON-STRETCH

Article number: 5.71032.x  
Size: S to XL



## X-CHEST POSITIONING FLEX-CONTROL / NON-STRETCH

Article number: 5.71034.x  
Size: S to L

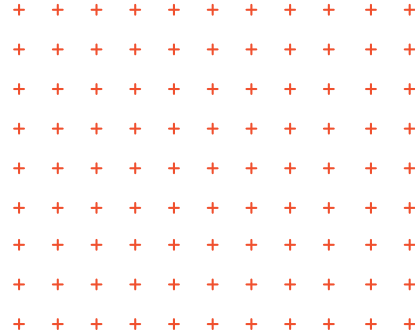

Flex-Control System

The Chest Positioning Non-Stretch harnesses give more substantial trunk support than the Chest Positioning Stretch harnesses, as they have an extra reinforced layer. Their unique Flex-Control system is specially designed for users experiencing spasms. It balances freedom and security, allowing people to be fixated on one simple pull of the Flex-Control while a seizure lasts. And as soon as the moment pass through, the system can be released, and the user can enjoy comfort again.

	A	B	C	D	E
S	70	50	320	105	220
M	100	50	400	130	270
L	145	50	480	150	300
XL	150	70	540	160	330

All measurements in mm

## H-CHEST POSITIONING FLEX-CONTROL / NON-STRETCH

Article number: 5.81001.x  
Size: S to XL



The H - Chest Positioning Flex-control / Non-Stretch allows for an asymmetrical positioning. A side release buckle in the middle of the harness allows the harness' padded parts to be adjusted by a tension release.



# POSITIVE POSITIONING

---





# PELVIC POSITIONING



## PELVIC POSITIONING NON-STRETCH

Article number: 7.70001.x  
Size: S to XL



## PELVIC POSITIONING STRETCH

Article number: 7.70002.x  
Size: S to XL

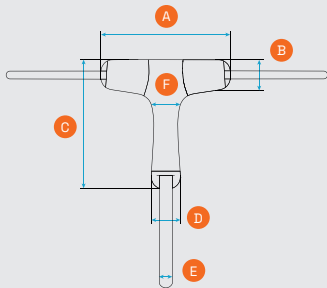

	A	B	C	D	E	F
S	185	190	45	55	45	200
M	240	240	45	60	50	250
L	320	320	60	70	60	380
XL	420	420	70	80	85	380

All measurements in mm

# ANKLE POSITIONING



## ANKLE POSITIONING HOOK AND LOOP CLOSURE

Article number: 8.70001.x  
Size: S to L

## ANKLE POSITIONING SIDE RELEASE

Article number: 8.70002.x  
Size: s to L

ALWAYS MUST BE USED  
IN COMBINATION WITH A HIP BELT



Contour of the malleolus  
lateralis/medialis

O < 18cm = XS  
< 22cm = S  
< 26cm = M  
> 26cm = L

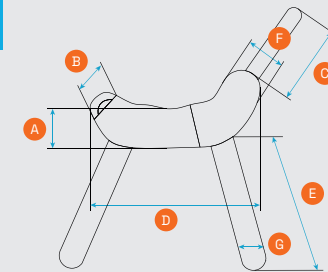

	A	B	C	D	E	F	G
XS	40	50	195	45	80	210	20
S	40	60	225	50	110	210	25
M	50	60	280	60	140	260	38
L	50	65	310	60	170	260	38

All measurements in mm







# ASSORTED POSITIONING PRODUCTS

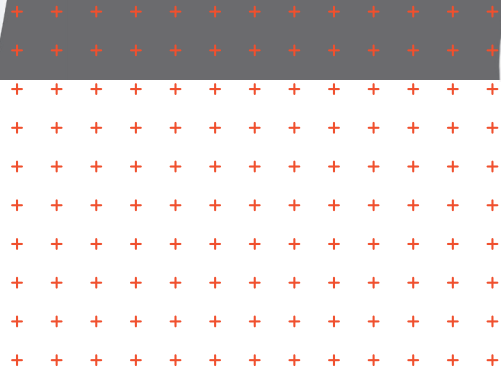

## NEOPRENE CHEST BELT X

Article Number: 402x  
Size: X to L

	A	B	C
XS	310	80	25
S	400	100	38
M	460	110	38
L	570	130	38

All measurements in mm

The Neoprene Chest Belt X's wide shape positions the person's body correctly while its stretchy material allows for respiration. The belt is suitable for users who need trunk support yet freedom during movement of their shoulder area.

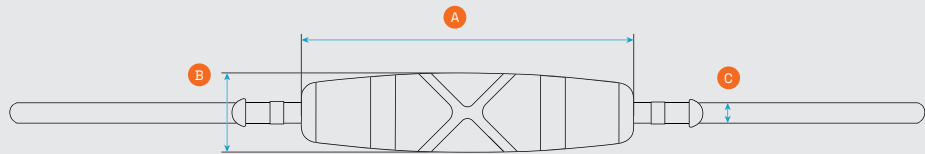

## CHEST BELT V1

Article Number: 400x  
Size: S and L

	A	B
S	1790	50
L	2190	100

All measurements in mm

The Chest Belt V1 is designed to be used by people who need substantial trunk support yet freedom in the shoulder area. The product is made with a 'hook and loop' closure so that it can be easily adjusted.

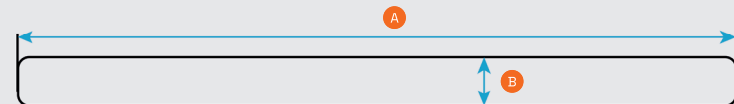



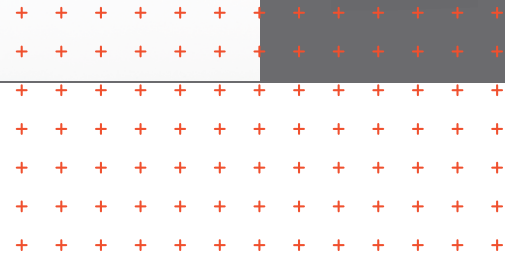

### SHOWER BELT

Article Number: 300x  
Size: S to L

	A	B	C
S	330	110	38
M	430	110	38
L	510	110	38

All measurements in mm

The Shower Belt is a 2-point Hip Belt intended to be used during showering. The belt secures and positions the user's pelvis in their shower chair, and this mesh material lets the belt dry quickly after use.

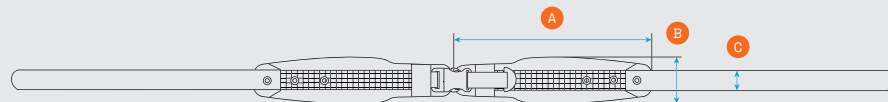

### NEOPRENE MULTI-PURPOSE BAND

Article Number: 500x  
Size: S to L

	A	B
S	1100	90
M	1300	100
L	1500	140

All measurements in mm

The Multi-Purpose Band is a simple yet highly functional product that can be used in various ways. As the outer side of the band is entirely made from a soft 'hook and loop' material and its inner side carries two long straps of hard 'hook and loop', it can be easily adjusted to fit everyone. Also, the inner side of the Multi-Purpose band has a wide grip print that ensures the belt's correct positioning and prevents slippages.

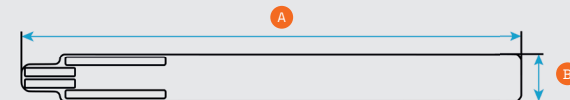

# PRODUCT CHARACTERISTICS

Our products have been designed to give postural support to our users, as having a good posture contributes to more energy at the end of the day and better health. Positioning Products' belts and harnesses are durable and designed for safe and easy use.



WATER AND DIRT REPELLENT



PREMIUM QUALITY MATERIALS



TRIMSTRIP

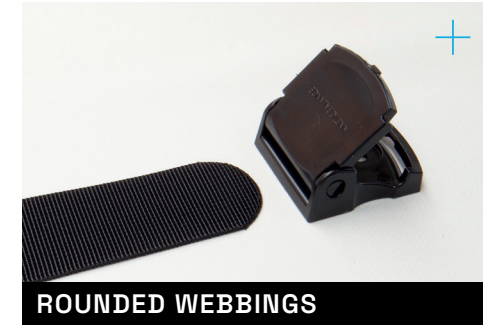

ROUNDED WEBBINGS



COVERED FASTENERS



MATERIAL REINFORCEMENTS



CLEAR SIZE INDICATION



CE MARKED PRODUCT



SUPER-DURABLE STITCHING



GRIP PRINT



QUALITY CONTROL

## UNIQUE FEATURES BY KINETIC BALANCE POSITIONING PRODUCTS

At Positioning Products, the user's safety is among our top priorities. And as buckles are a key element in all our products, most of them are covered with a pocket to protect the user from their sharp edges. The harnesses have a grip print on their inner side to secure the product's correct position on the person's body and prevent unintentional movements. All Positioning Products are made from water and dirt-repellent materials, ensuring longevity. When it comes to comfort, it is essential to highlight that the webbings on our products have rounded edges and a trim strip, guaranteeing their seamless and precise mounting on any wheelchair.

### AND MORE...

- ISO 9001:2015 Production Facility
- Soft Neoprene Edge
- Wrinkle-Free Webbing



# PRODUCT OVERVIEW & ARTICLE NUMBERS

## HIP

2-point Esesntial Hip Belt Single Adjustable		
6.70000.2	M	

2-point Hip Belt Side Release Double Adjustable		
6.70001.0	XS	
6.70001.1	S	
6.70001.2	M	
6.70001.3	L	
6.70001.4	XL	

2-point Hip Belt Side Release Single Adjustable		
6.70002.0	XS	
6.70002.1	S	
6.70002.2	M	
6.70002.3	L	
6.70002.4	XL	

2-point Hip Belt Centre Release Single Adjustable		
6.70003.0	XS	
6.70003.1	S	
6.70003.2	M	
6.70003.3	L	
6.70003.4	XL	

2-point Hip Belt Centre Release Double Adjustable		
6.70004.0	XS	
6.70004.1	S	
6.70004.2	M	
6.70004.3	L	
6.70004.4	XL	

2-point Hip Belt Pin Release Double Adjustable		
6.70005.0	XS	
6.70005.1	S	
6.70005.2	M	
6.70005.3	L	
6.70005.4	XL	

2-point Hip Belt Aviation Release Single Adjustable		
6.70006.1	S	
6.70006.2	M	
6.70006.3	L	
6.70006.4	XL	

4-point Hip Belt Side Release Single Adjustable		
6.70042.0	XS	
6.70042.1	S	
6.70042.2	M	
6.70042.3	L	
6.70042.4	XL	

4-point Hip Belt Centre Release Double Adjustable		
6.70043.0	XS	
6.70043.1	S	
6.70043.2	M	
6.70043.3	L	
6.70043.4	XL	

4-point Hip Belt Side Release Double Adjustable		
6.70044.0	XS	
6.70044.1	S	
6.70044.2	M	
6.70044.3	L	
6.70044.4	XL	

4-point Hip Belt Pin Release Double Adjustable		
6.70045.0	XS	
6.70045.1	S	
6.70045.2	M	
6.70045.3	L	
6.70045.4	XL	

4-point Hip Belt Centre Release Single Adjustable		
6.70047.0	XS	
6.70047.1	S	
6.70047.2	M	
6.70047.3	L	
6.70047.4	XL	

## CHEST

Chest Positioning Stretch		
5.71012.0	XS	
5.71012.1	S	
5.71001.0	Junior	
5.71012.2	M	
5.71012.3	L	

X-Chest Positioning Stretch		
5.71014.1	S	
5.71014.2	M	
5.71014.3	L	

Chest Positioning Zipper Stretch		
Z5.71022.1	S	
Z5.71022.2	M	

Chest Positioning Flex-Control/Non-Stretch		
5.71032.1	S	
5.71032.2	M	
5.71032.3	L	
5.71032.4	XL	

X-Chest Positioning Flex-Control/Non-Stretch		
5.71034.1	S	
5.71034.2	M	
5.71034.3	L	

H-Chest Positioning Flex-Control/Non-Stretch		
5.81001.1	S	
5.81001.2	M	
5.81001.3	L	
5.81001.4	XL	

## PELVIC

Pelvic Positioning Non-Stretch		
7.70001.1	S	
7.70001.2	M	
7.70001.3	L	
7.70001.4	XL	

Pelvic Positioning Stretch		
7.70002.1	S	
7.70002.2	M	
7.70002.3	L	
7.70002.4	XL	

## ABDUCTION

Abduction Positioning		
9.70001.0	XS	
9.70001.1	S	
9.70001.2	M	
9.70001.3	L	

## ANKLE

Ankle Positioning Hook and Loop Closure		
8.70001.0	XS	
8.70001.1	S	
8.70001.2	M	
8.70001.3	L	

Ankle Positioning Side Release		
8.70002.0	XS	
8.70002.1	S	
8.70002.2	M	
8.70002.3	L	

## ASSORTED PRODUCTS

Neoprene Chest Belt X		
4020	XS	
4021	S	
4022	M	
4023	L	

Neoprene Multi-Purpose Band		
5001	S	
5002	M	
5003	L	

Shower Belt		
3001	S	
3002	M	
3003	L	

Chest Belt V1		
4001	S	
4003	L	

# POSITIONING PRODUCTS

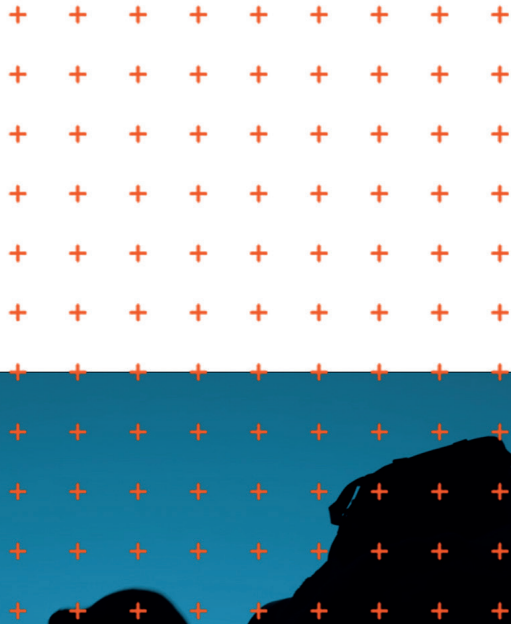

 **KINETIC  
BALANCE**  
POSITIONING  
PRODUCTS

Scheepmakerstraat 27  
2222 AB Katwijk aan Zee  
the Netherlands

T: +31 (0) 712048424  
E: [mail@positioningproducts.nl](mailto:mail@positioningproducts.nl)

[WWW.POSITIONINGPRODUCTS.NL](http://WWW.POSITIONINGPRODUCTS.NL)

